

# *ζetasinter*

High Temperature tube furnace

Operations Manual



NANOE SAS

[CONTACT@NANOE.COM](mailto:CONTACT@NANOE.COM) |

+33.9.81.98.33.64

6 RUE DES FRENES 91160

BALLAINVILLIERS

FRANCE

Thank you for purchasing the Zetasinter furnace. The latest version of this manual is available on our website [www.zetamix.fr](http://www.zetamix.fr). To avoid any misuse and damage, please read it carefully before using.

## Content

1. Furnace Description .....	3
2. Technical Specifications .....	3
3. Safety .....	4
a. <b>Intended use</b>	
b. <b>Assembling</b>	
c. <b>Operation</b>	
d. <b>Maintenance</b>	
4. Assembling .....	7
5. Temperature controller.....	9
6. Alumina tube and refractory blocks.....	14
7. Vacuum pump & flowmeter.....	19
8. Bubbler .....	20
9. MoSi2 Heating elements.....	21
10. Troubleshooting .....	22
11. Electrical schematic diagram.....	24
12. Quick start procedure .....	25
13. Facility guide.....	26
14. EU Declaration of conformity (No 2018-11-a).....	32

## 1. Furnace Description

The **Zetasinter Tubular Furnace** is a tubular furnace using MoSi2 heating elements and a high purity alumina tube, working temperatures are between 800°C and 1550°C. Zetamix printed parts must be placed inside the tube sealed with flanges. Depending on the material, they can be sintered in an ambient or inert atmosphere.

## 2. Technical Specifications

Type	Zetasinter Tubular
Power	6 kW
Connection	1/N/PE
Voltage / Frequency	200-240V ~ / 50/60Hz
Maximum temp.	1600°C
Working Temp.	1550°C
Suggested heating rate	≤ 3°C/min
Temperature controller accuracy	±1°C
Thermocouple	B type
Heating elements	U type MoSi2
Size	860x605x1120mm – 112 kg
Chamber size	Ø90x100 or 200mm (without alumina plate)

## 3. Safety

### a. Intended use

Only parts printed with Zetamix by Nanoe® filaments can be heat treated in Zetasinter. Reference names of Zetasinter by Nanoe® filaments are:

- Zetamix H13 Steel®
- Zetamix H13 Steel®
- Zetamix White Zirconia®
- Zetamix Black Zirconia®
- Zetamix Alumine®

Installation must be done according the Zetasinter facility guide.

Installation, use and maintenance must be done according to this operation manual.



The set-up instructions and safety regulations must be observed, otherwise the furnace will be deemed to have been used incorrectly, effectively cancelling any claims against Nanoe.

### b. Assembling

Assembling must be done according to this operation manual.



Danger due to electrical Current.  
During installation and maintenance work, the electric supply to the furnace must be switched off.  
Work on electrical equipments may only be performed by qualified personnel.

Only the vacuum pump can be connected to the socket on the side of the furnace body.

## c. Operation

### Temperature controller

For each material reference, the heat program must be defined by the operator according to guidelines provided by Nanoe ([www.zetamix.fr](http://www.zetamix.fr)).

The maximum safety temperature is set at 1600°C. Above, the temperature controller automatically stops the heat treatment.

The recommended maximum working temperature is 1550°C.

Heating and cooling rates may not exceed 3°C/min (except emergency stop).

Do not turn off the power supply of the equipment if the furnace temperature is above 500°C.

After replacing the temperature controller, its settings must be adjusted before use.

### Alumina tube and refractory blocks

Put the refractory blocks on both sides of the tube before starting a heating cycle and wait until the furnace temperature drops to room temperature (<100°C) before removing them.

Do not touch the inner or outer surface of the furnace during or immediately after use.

Do not place any objects on the furnace body.



Hot surfaces, danger of burning.  
You may not always realize that surfaces, such as the furnace walls, tube and crucible are hot. Do not touch the surface.

### Vacuum pump

Check the oil level before use.

### Gas supply

Working at a positive relative pressure is not recommended for the alumina tube. The relative pressure must not exceed 0.2 bar (0.02 MPa). Inlet and outlet flanges must remain open during the heat treatment. Switch off the furnace (hold or stop conditions) if the pressure exceeds 0.2 bar (0.02 MPa) and/or the bubbler is not bubbling.



Positive relative pressure is not recommended for this product. The relative gas supply pressure should not exceed 0.2 bar (0.02 MPa) and the flanges should be properly adjusted.



Inert gases such as argon are dangerous because of the risk of asphyxiation.  
The working area must be ventilated using an appropriate ventilation system.  
The use of an oxygen monitor is recommended.

## d. Maintenance

The power supply must be switched off before any maintenance work.



Danger due to electrical current.

During installation and maintenance work, the electric supply to the furnace must be switched off.

Work on the electrical equipment may only be performed by qualified personnel.

## 4. Assembling



Danger due to electrical current.  
 During installation and maintenance work, the electric supply to the furnace must be switched off.  
 Work on the electrical equipment may only be performed by qualified personnel.

- Install the furnace according to the facility guide (chapter 13).
- Remove the plastic cover from the heating elements under the top cover (remove the screws to do this).



- Install the alumina tube. Put the refractory blocks on both sides of the tube (cf. Alumina tube chapter).
- Close the circuit breaker, turn on the power → the green light comes on and the cooling fan starts to work.
- Turn the “lock” button clockwise → the temperature control unit is now switched on.
- Press the “Turn On” button (green light is now on).

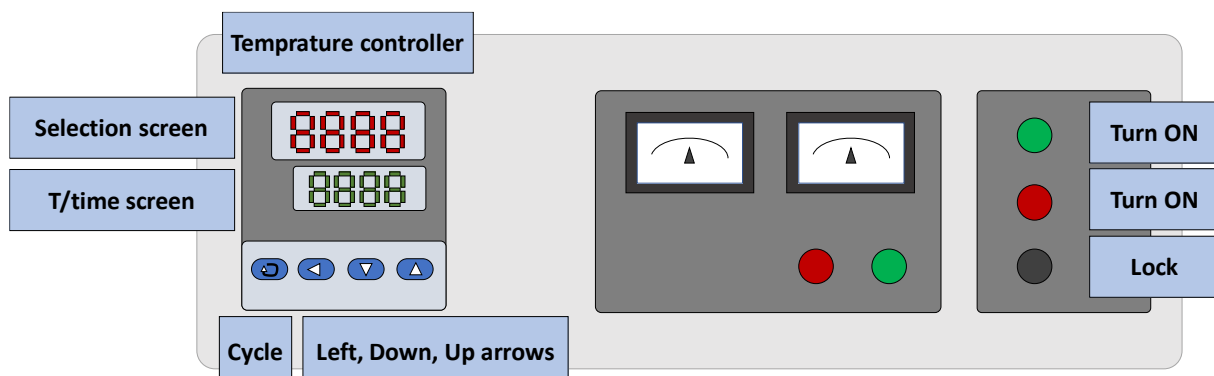

- For the first heating, the furnace chamber must be “baked” for 2 hours at 300°C. Using the temperature controller, program and run the "baking" cycle (cf. Temperature controller chapter):  
**(C01=50; t01=85; C02=300; t02=120; C03=300; t03=65; C04=100; t04=-121)**
- For the first high temperature heating (above 400°C), heating element must be “passivated” for 2 hours at 1200°C (cf. heating element chapter). Using the temperature controller, program and run the "passivation" cycle:  
**(C01=50 ; t01=385 ; C02=1200; t02=120; C03=1200; t03=365; C04=100; t04=-121)**
- Install the vacuum pump and the flowmeter (cf. Vacuum pump & flowmeter chapter).
- Install the bubbler (cf. Bubbler chapter).



## 5. Temperature controller

### Heating program setting

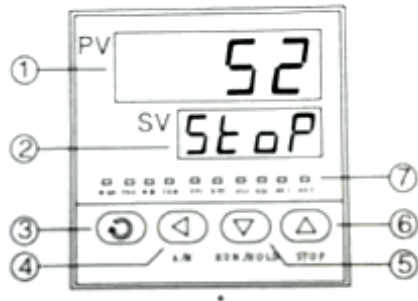

- ① Process value (Thermo couple temperature °C) (P V)
- ② Setting value (temperature °C- Program state\*) (S V)
- ③ Setting key (confirm KEY)
- ④ Data shift key (and program setup entry)
- ⑤ Data reduction key (and program RUN/HOLD)
- ⑥ Data add key (and program STOP)
- ⑦ Function indicator :
  - PRG controller in running state
  - OP1 power output
  - OP2 power output level

### Program state symbols

Symbol	Description
StoP	Program stop state
HoLd	Program hold state
rdy	Program ready state
orAL	Input specification setting is incorrect or input wiring is disconnected/thermocouple problem or short circuited
HIAL	High limit alarm
LoAL	Low limit alarm
HdAL	Deviation high alarm
LdAL	Deviation low alarm
EErr	IC software error
8888	IC software error

### Stop state

When you turn on the "Lock", the temperature controller displays the model and version. After a few seconds, it switches to the off-state.

- PV : "TC temperature" (50°C at room temperature).
- SV : "StoP" is alternately displayed on the lower window.



## Heating program setting

- ① From stop state, Press  to go to the setup program state.



- ② The set points of the step StEPXX are displayed (C XX temperature in °C, and t XX time in min). Be careful of the coma for the time on the new versions of the oven.



- ③ Press ,  and  to modify the value.



- ④ Press  to move to the next parameter. The program parameters are displayed in the following order: setpoint1, time1, setpoint2, time2.



- Press and hold  to return to the previous setting. The program step can be changed at any time, even if the program is running.

- ⑤ Set txx= -121 to indicate the end of the program (automatic switch-off).



- ⑥ Press  and  simultaneously to exit the settings. If no key is pressed within 25 seconds, it also exits to stop state.

**Example:**

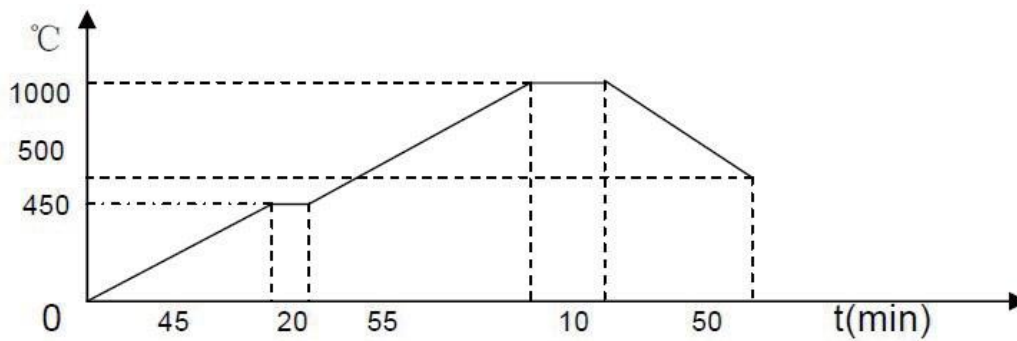

Steps	Symbol	Input	Meaning in the program
SP1	C 01	0 (°C)	Start Temperature 0 °C (The temperature controller have the auto compensation Function ,when controller start work, will rise temperature based on the thermocouple tested )
	t 01	45 (min)	Stats Temperature heating up from 0 to 450°C, and the time needed 45 minutes to SP2(450 °C). Slope of raising curve is 10°C /minute.
SP2	C 02	450 (°C)	The program takes 45minutes to raise temperature to SP2.
	t 02	20 (min)	It means Keep same temperature in 20 minute to SP3.
SP3	C 03	450 (°C)	Start Temperature heating up from 450°C to 1000°C
	t 03	55 (min)	The program takes 55minutes to raise temperature to SP4
SP4	C 04	1000 (°C)	Stats Temperature heating up from 450°C to 1000°C, and the time needed 55 minutes to SP4(1000 degree). Slope of raising curve is 10°C /minute.
	t 04	10 (min)	It means Keep same temperature in 10 minutes to SP5
SP5	C 05	1000 (°C)	This is the step for the temperature cooling down form the 1000°C to 500°C, slope of cooling curve is 10°C /minute.
	t 05	50 (min)	The time needed is 50 minutes to reach (500°C), to SP6.
SP6	C 06	500 (°C)	This is the temperature to be cooled ( 500°C)
	t 06	-121	Program end

**Specific settings:**

## Time Setting

Time set(min)	Meaning
Set “t × ×”=1~9999	Set the time of × × StEP.(Time units can be change to Hour by parameter “PAF”)
Set “t× ×” =0	The program hold on StEP× ×,program will hold running and hold counting time.
Set “t× ×=-121”	The program stops, and switches to stop state

## Heating programs saving

Code	Input data	meaning
C01	0	
T01	-2	execute the program of group curve(2-5) ,this is step 2
C02	0	start temperature value from 1st group curve
t02	45	1st group curve 1st step running time
C03	450°C	first group curve: temperature value of 1st turning point
t03	100	1st group curve 2nd step running time
C04	1500°C	First group: temperature value of 2nd turning point
t04	20	1st group curve 3rd step running time
C05	1500°C	First group curve: temperature value of 3rd turning point
t05	-121	When program stop, the step will be set to 1 and execute "stop", cooling down naturally.
C06	0	set T01 to -6,means operation execute 2nd group(6-9), set this to Step 6; 2nd group curve Initial Temperature
t06	60	2nd group curve 1st step running time
C07	600°C	2nd group curve: temperature value of 1st turning point
t07	100	2nd group curve 2nd step running time
C08	1600°C	2nd group curve: temperature value of 2nd turning point
t08	20	2nd group curve 3rd step running time
C09	1600°C	2nd group curve: temperature value of 3rd turning point
t09	-121	Program end and return to 1st group then execute stop process, cooling down naturally

## Run/Hold states

### Run state:

In Stop state, press and hold  until the SV window displays the “run” symbol. The controller runs the defined program.



### Hold state:

In Run state, press and hold  until the SV window displays the “HoLd” symbol. Controller holds the given temperature and stop the timer.



In Hold state, press the  until the SV window displays the “run” symbol. Controller starts running again.

### Step number and timer:

In Run or Hold states, press  to display the current step number and timer (PV: current step time setting and SV: current step elapsed time).



### Return to Stop state:

In Run or Hold states, press, and hold  until the SV window displays the “StoP” symbol. The controller will stop (free cooling), the timer will be reset, and the step number will be set to 1.

## 6. Alumina tube and refractory blocks

### Alumina tube



- ① Switch off the power supply.
- ② Install the heat shields.
- ③ Carefully insert the tube into the furnace, keep it straight to avoid breaking the heating elements. Keep an equal length of tube at both ends of the furnace.
- ④ Install the tube holders.



Wrap the threads with PTFE tape and connect the pressure gauge and intake valves to the flanges:

Right: Inlet flange (OD 6mm connection to the gas supply)



Left: Outlet flange (OD 10mm connection to the vacuum pump or to the bubbler)





The installation of the sealing flanges is shown in the figure below:



Install the right flange (inlet flange):

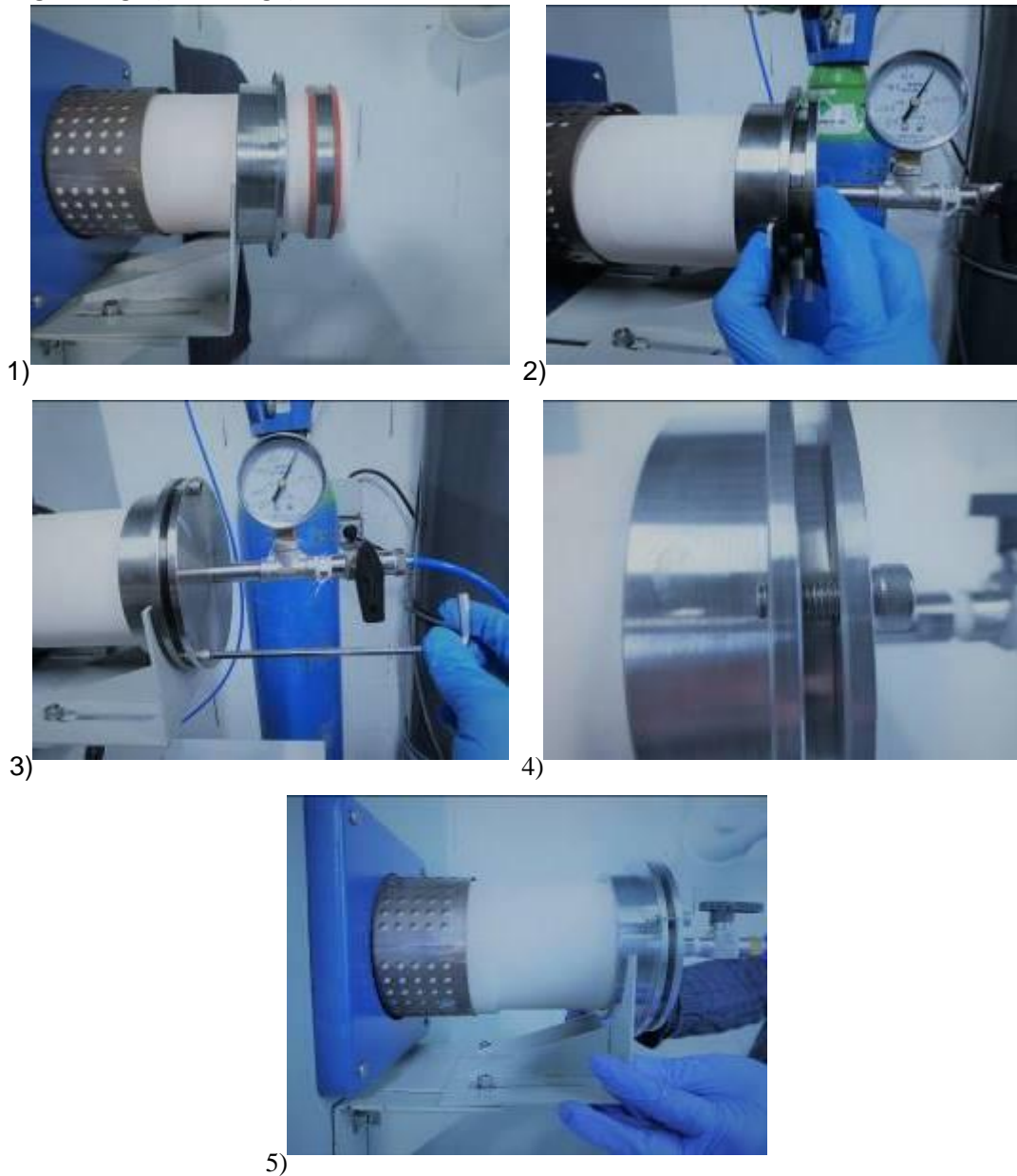

Install the left flange (outlet flange) :

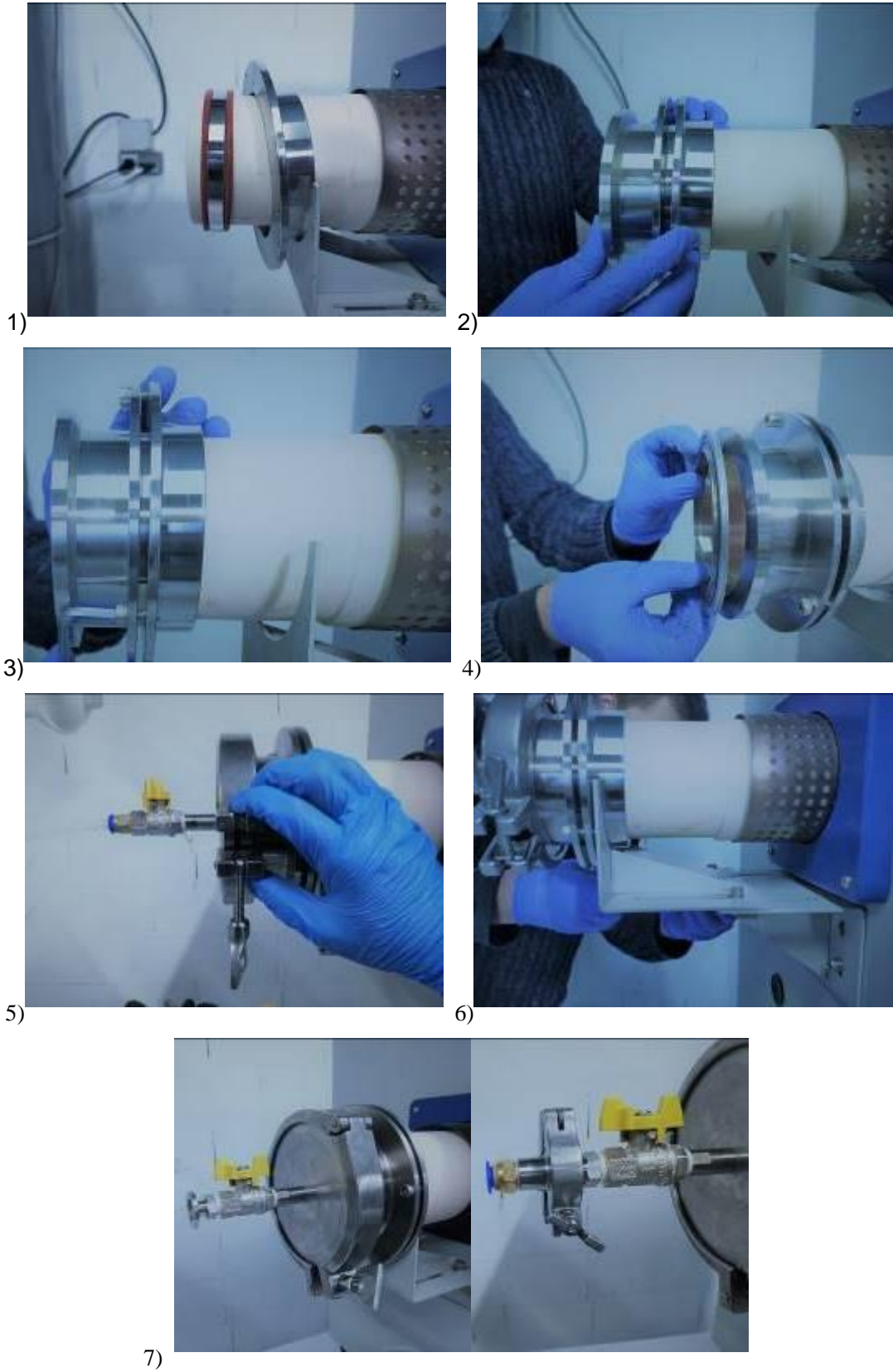

Adjust the position of the tube holders under the flanges, they must be in contact with the flanges.



## Use: refractory blocks and alumina plate



- Install the four refractory blocks and the two alumina plates as shown in the figure below.
- Two refractory blocks must be placed in contact with the crucible.
- It is recommended to use marks on the crucible hook to help placing.
- If the refractory blocks are not positioned correctly, this can lead to tube and part failures.

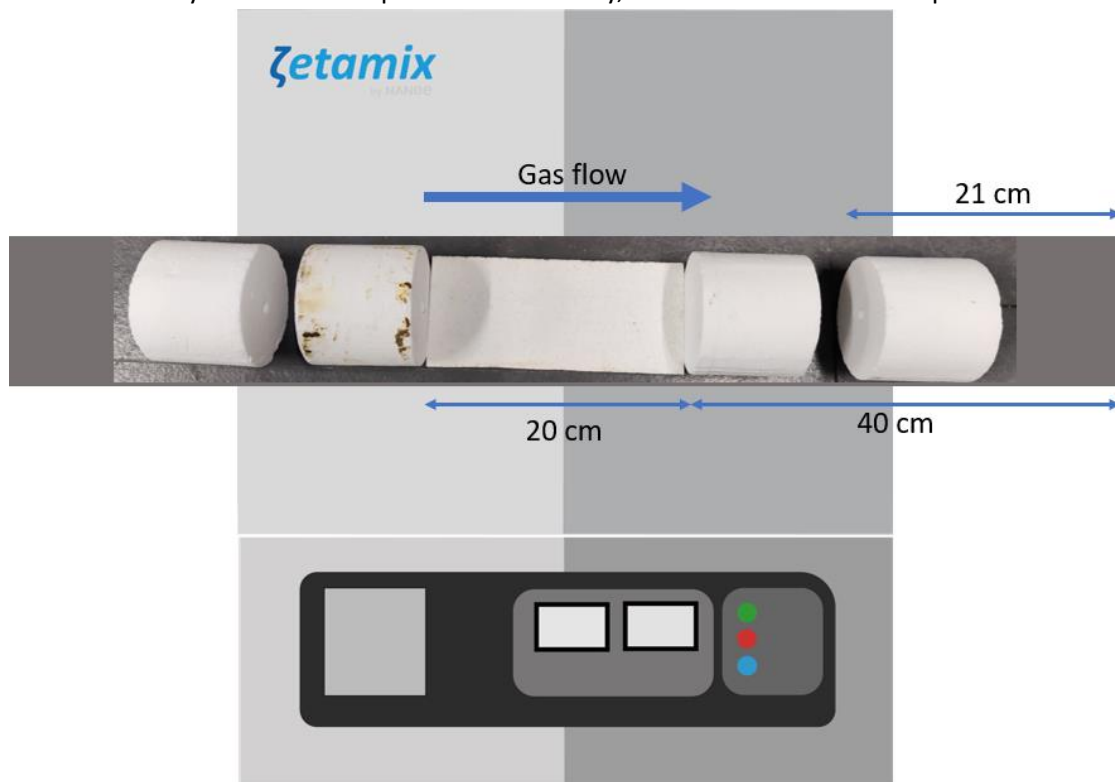

## Maintenance

### After every heat treatment:

- Clean the binder residues in the outlet flange with hot water or a degreaser. Use a bottle brush to clean the outlet valve. Please note that only refractory blocks are required to debind/sinter Zetamix ceramics. No need to put and close the flanges.



After five heat treatment:

- If the refractory blocks and the alumina plate are black due to binder residue. Program and run an “cleaning cycle” under ambient atmosphere (inlet and outlet valves open):

**(C01=50; t01=690; C02=1200; t02=10; C03=1200; t03=300; C04=200; t04=-121)**

## 7. Vacuum pump & flowmeter

### Vacuum pump

- ① Unscrew the blue vacuum pump cap and inject the appropriate amount of oil. Put back the vacuum pump cap without (without the small black cover).
- ② Plug the vacuum pump into the socket on the side of the furnace body.
- ③ Connect the vacuum pump to the outlet flange using the  $\varnothing 10\text{mm}$  flexible air hose.



### Old Flowmeter

- ① Install the flowmeter on its holder.
- ② Connect its outlet (upwards) to the inlet flange with the  $\varnothing 6\text{mm}$  flexible air hose.
- ③ Connect its inlet (downwards) to the 0.2 bar (0.02MPa) gas supply (1/8 NPT F).

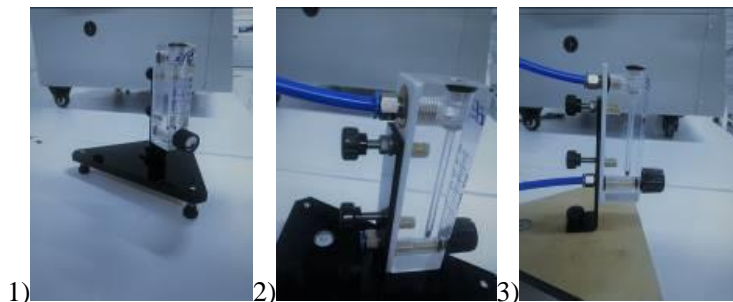

### New Flowmeter

- ① Install the flowmeter on its 3D printed holder and use the two screws on the side of the oven to attach it.
- ② Connect its outlet (upwards) to the inlet flange with the  $\varnothing 6\text{mm}$  flexible air hose.
- ③ Connect its inlet (downwards) to the 0.2 bar (0.02MPa) gas supply (1/8 NPT F).

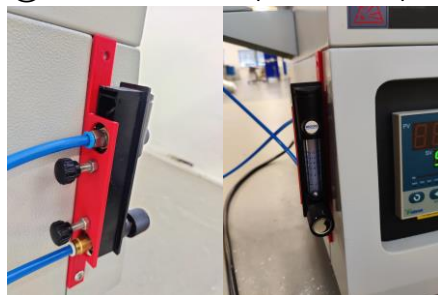

### Use: Vacuum test

- Check the oil level in the pump
- Close the valves and the flowmeter.

- Turn on the pump.
- Open the outlet valve.
- Wait till the tube pressure is under -0.9 bar (-0.09 MPa).
- Close the outlet valve.

The vacuum test is positive if it is possible to keep a static vacuum under - 0.9 bar (-0.09 MPa) during more than 5 min.

## 8. Bubbler

- ① Connect the bubbler to the outlet flange with the o-ring (may need grease). Remember to keep the inlet and outlet valves closed when doing this.
- ② Seal the connection by closing the clamp slightly.
- ③ Fill the bubbler with 70 mL of water (level at 110 mm height from the bottom).
- ④ **Slowly** open the outlet valve (let the overpressure released to 0 bar) and set the flowmeter to 0.5 L/min (or according to the filament guideline).
- ⑤ Set the heat treatment, during it:
  - Adjust the water level to 110 mm every 48 hours to compensate the evaporation.
  - Inlet and outlet flange must be kept opened.
  - Stop the furnace (hold or stop states) if the pressure is higher than 0.2 bar (0.02 MPa) and/or the bubbler is not bubbling.

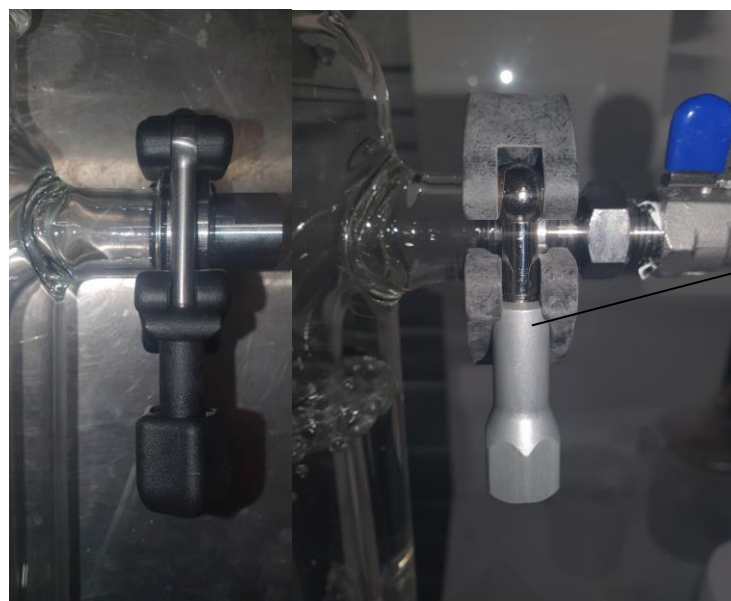
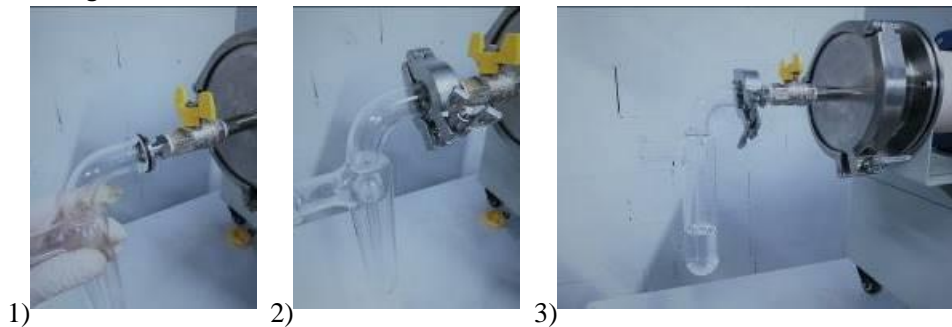

Maximum tightening :  
The end of the threading  
must stay visible.

## Maintenance

### After every heat treatment:

- Clean the binder residues with hot water or a degreaser and a bottle brush.

## 9. MoSi2 Heating elements

In order to form a protective layer against oxidation, new heating elements must be heated to 1200°C for 2 hours with a ramp of 3°C/min (cf 4. Assembling). This process should be done when using a Zetasinter for the first time or after replacing the heating elements.

The resistance of MoSi2 heating elements increases with use and the performance of the furnace may decrease. Used MoSi2 heating elements are very brittle, especially after heat treatment at 1200°C.

New and used MoSi2 heating elements can be used together.

### Replacement

The power must be turned off before maintenance or inspection.

- ① Unscrew the top cover and remove it.
- ② Unscrew of the clip of the connection bridge (for each rods of the U type heating element) and remove it.
- ③ Take off the connection bridges.



- ④ Unscrew the clip from the ceramic jaws that hold the heating element.
- ⑤ Remove the ceramic jaws and the refractory block.
- ⑥ Remove the heating element which needs to be replaced.
- ⑦ Replace it with a new heating element. Replace the refractory block and ceramic jaws, make sure they all fit in the same position as before.

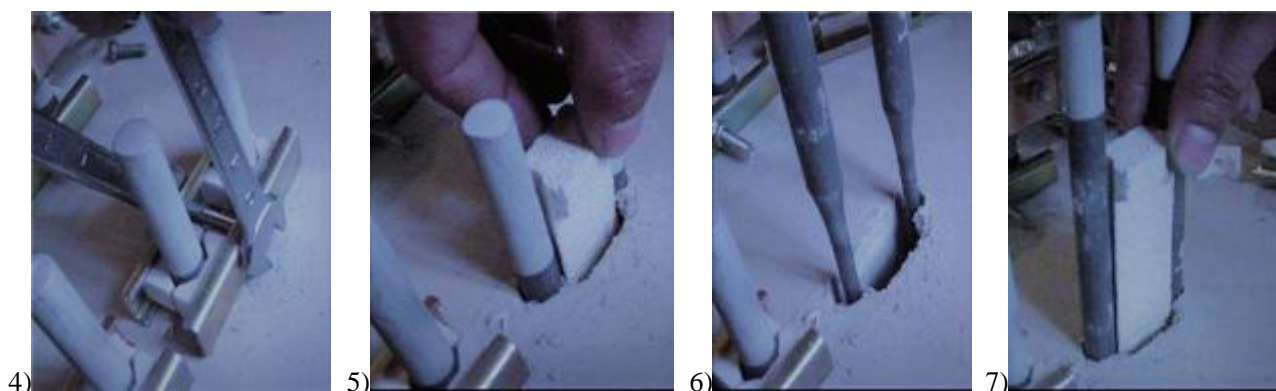

- ⑧ When tightening the clip screw, make sure that the bottom of the heating element does not touch the bottom of the furnace chamber.
- ⑨ Then follow the procedure ④③②① to tighten the screw and complete the heating element replacement.

## 10. Troubleshooting

Failure	Code 1	Code 2	Explanation(s)	Solution
No power	/	/	The furnace is not connected to the power supply.	Check the power supply and the electrical connection.
				Check and close the 32A circuit breaker on the furnace body (left).
Lock key is turned clockwise (right) but the temperature controller is not switched on.	/	/	The control circuit is not connected to the power supply because its 2A circuit breaker is open.	Identify (if possible) the cause of the failure.
				Check and close the 2A circuit breaker inside the furnace (behind the control panel).
No heating power.	Heating elements voltage and current are 0 while the temperature controller is on run state.	The green "power" light is on, and the red "open circuit" light is off.	The temperature controller is locked.	Adjust the LOC parameter and set it to 0 (contact the after-sale service).
		The green "power" light is off, and the red "open circuit" light is on.	The heater power circuit is not connected to the power supply because its 32A circuit breaker is open.	Identify (if possible) the cause of the failure.
				Check and close the 32A circuit breaker inside the furnace (behind the control panel).
		The green "power" light is off and the red "open circuit" light is off.	Same as the previous failure and the red light is broken.	Same as the previous failure and change the red light.
	The current of the heating elements is 0 while their voltage is maximum.	/	A heating element is broken.	Identify which heating element is broken and change it. Check first under the top cover and then inside the heating chamber.
Controller panel SV indicate "Oral"	/	/	The thermocouple circuit is broken.	Change the thermocouple.
Controller panel SV indicate "Hial"	/	/	Furnace temperature >Max	Let the furnace cool down. Check the temperature controller and the thermocouple.



Failure	Code 1	Code 2	Explanation(s)	Solution
Impossible to do vacuum under -0.1 bar (-0.01 MPa)	/	/	-Exhaust gas circuit is closed. -Inlet gas circuit is open. -Important leakage.	Check the position of the valves.
				Check the outlet flange for dirt.
				Check if the tube is broken (It is possible to turn the tube slightly to one side, if it turns to the other side too, it is certainly not broken).
Vacuum test is negative (impossible to maintain static vacuum under -0.9 bar (-0.09 MPa) for more than 5 min.	/	/	Small leakage.	Check the flange seals.
Impossible to maintain a constant inlet gas flow of 0.5 L/min.	/	/	0.2 Bar (0.02 MPa) gas supply is not stable.	Use an appropriate gas supply (double stage 0.1 bar (0.01 MPa) precision → cf. Facility Guide)
The bubbler doesn't bubble while the flowmeter and valves (inlet and outlet) are open.	Tube pressure is at 0 bar (MPa)	/	No gas supply. The gas supply circuit is closed.	Turn off the furnace (hold or stop-state). Check the flow meter and the inlet valve installation. Check the gas supply.
			Important leakage.	Check if the tube is broken (It is possible to turn the tube slightly to one side, if it turns to the other side too, it is certainly not broken). To quickly check, do a vacuum test. If it doesn't maintain at -0.9 bar (-0.09 MPa), the tube could be broken.
	The tube pressure is ≥ 0.2 bar (0.02 MPa)	/	Outlet flange is clogged.	Switch off the furnace (hold or stop state). Check the installation of the outlet valve. Check the outlet flange for dirt (after the furnace has cooled down).

## 11. Electrical schematic diagram

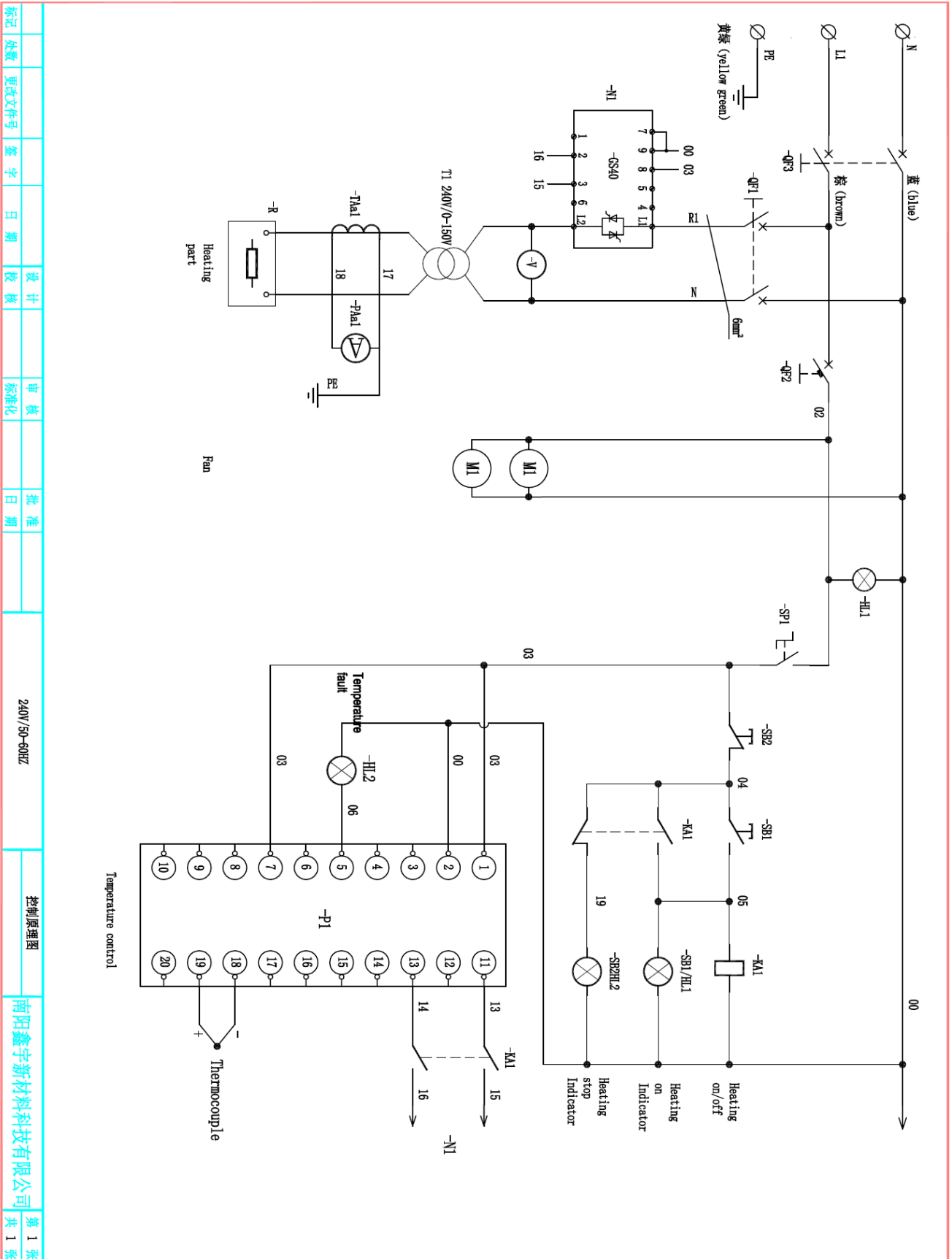

Zetasinter Tubular – 200-240V 50/60Hz



## 12. Quick start procedure

### HEATING CURVE SETTING

1. Turn on the temperature controller by turning the LOCK button.
2. The temperature controller is initializing and then displays the initial screen.
3. Press the LEFT ARROW button to display the heating curve setting.
4. The screen is now displaying the first segment (**C 01**) and the associated temperature. This temperature can be modified by pressing the UP or DOWN ARROWS. After pressing the UP or DOWN ARROWS for a few second, the decimal point will be displaced to the left in order to change the temperature faster. With the side arrows, you can choose to change the number of units, tens, hundreds...
5. Once the first temperature is set, press the CYCLE button to move to the first segment time setting (**T 01**). You can change the time displayed in minutes by pressing the UP or DOWN ARROWS. With the side arrow, you can choose to change the number of units, tens, hundreds...
6. Then you can cycle through the segment by pressing the CYCLE button to build the desired heating curve. The number displayed by the letter C or T corresponds to the number of the segment.
7. Note that a plateau can be added by choosing the same temperature as the temperature of the previous segment. If so, the time setting of that segment corresponds to the time of the plateau.
8. Finally, when all segments are built, you must add a final step by choosing -121 as the temperature of the last segment and not assigning any time control to this step.
9. In order to exit the heating curve setting, you can wait 20s and the temperature controller will automatically return to the initial screen. You can check your heating curve by entering the heating curve setting again (back to point 3).

### RUN A HEATING CURVE

1. To run the selected heating curve, you must first press the TURN ON button to close the circuit breaker. The green button will light up.
2. Press the DOWN ARROW (run) for more than one second to start the heating curve.
3. You can hold the heating curve by pressing the DOWN ARROW for a little longer than one second. To resume the heating curve, press the DOWN ARROW again for more than one second. You can stop the heating curve by pressing the UP ARROW for more than one second.

## 13. Facility guide

	<p>The set-up instructions and safety regulations must be followed, otherwise the furnace will be deemed to have been used improperly, effectively cancelling any claims</p>
---	--

### Shipping and unloading

	<p>Suspended loads are dangerous. Working beneath a suspended load is prohibited. There is a risk of fatal injury. Safety and accident prevention guidelines applicable for forklift, stacker</p>
---	---

- A standard pallet truck or forklift (forks width 685 mm) is recommended to unload the crate.
- Pay attention to doors width for delivery (1300 mm minimum).
- An area of at least 3000x2000x2500 (LxWxH) mm is recommended to uncrate the furnace.

Crate dimension (LxWxH)	1200x800x1500 mm
Crate weight	≈200 kg
Contents of the crate	<ul style="list-style-type: none"> <li>o A Zetasinter furnace</li> <li>o A specific box with an alumina tube</li> <li>o Another box with spare parts</li> </ul>

### Moving and operating space

- The furnace has four wheels with brakes, however the using of a stacker is recommended to lift and lift down the furnace from the crate to the operating space.

Furnance dimension (LxWxH)	600x600x770 mm (without tube)
Weight	112 kg
Stacker Recommended	<div style="display: flex; align-items: center;">  <div> <p>Capacity : 250 kg Fork length : 800 mm Fork Width : 300 mm</p> </div> </div>

Zetasinter Operating area (mm) :

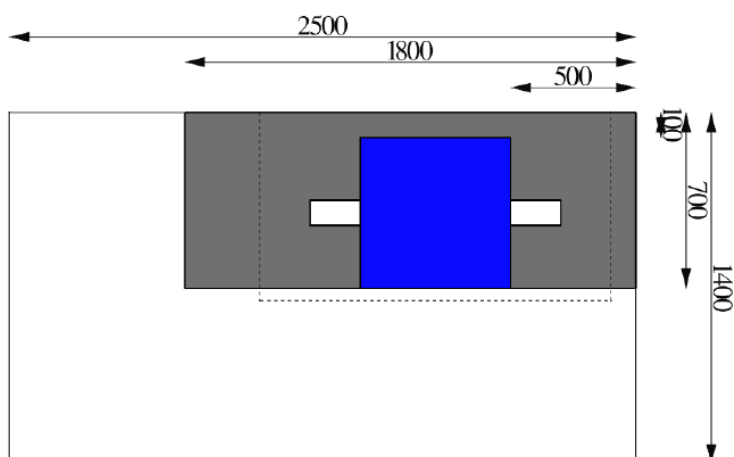

- For comfortable using experience it is recommended to install the Zetasinter furnace :
  - o in a 2500x1400 mm operating space
  - o on a work bench
  - o under an venting hood (cf. Environmental requirement)

Operating space surface (LxW)	2500 x 1400 mm	
Operating space Height (H)	2000 mm without working bench 2500 mm min. with working bench	
Work bench recommended		Material : Not flammable (stainless steel) Capacity : 500 kg LxWxH : 1800x800(700) mm

## Environmental requirement





Note :

This product does **not** comply with the ATEX Directive and may **not** be used in ignitable atmospheres.

- Laboratory/Factory environment without dust is recommended :

Room Temperature	5-35°C
Humidity	<70% (non-condensing)

- During thermal treatment the Zetasinter furnace released heat.
- The working area must be ventilated with a non-recycling venting system of 500 m<sup>3</sup>/h (300 CFM).

<p>Laboratory hood recommended for laboratory environment</p>	 <p>Size : 1730x800x1430 mm With controller Max flow : 2000 m<sup>3</sup>/h</p>
<p>Canopy hood recommended for factory environment</p>	 <p>Size : 1400x700mm With controller Max flow : 1400 m<sup>3</sup>/h</p>

## Electrical supply



	<p>This product does <b>not</b> have IP rate electrical plug. The connection to a 200-240V electric power supply is dangerous.</p> <ul style="list-style-type: none"> <li>- Electric connection must be carried out by qualified personnel.</li> <li>- The equipment must be connected to a safe and reliable power supply according</li> </ul>
--	---

- The power supply must be reliable :

<p>Power supply</p>	<p>Single-phase with Earth (ground)</p>
	<p>UE50 TYPE : 200-240V~ 50Hz Phase-Neutral US60 TYPE : 200-240V~ 60Hz Live-Live</p>

- The circuit from power supply to furnace must be a dedicated branch circuit :

<p>Circuit breaker Recommended</p>	<p>C 32A</p>
<p>Power cable Recommended</p>	<p>3G (3 Core) ≥6 mm<sup>2</sup> (&lt;11 AWG) Range – According to cable length</p>

<p>Power Connection Recommended</p>	<p>32A SP+N switch fuse-disconnector</p>  <p>Or</p> <p>32A 3 Pole non fused isolator switch</p>  <p>Or</p> <p>32A 2P+E power plug and socket</p> 
<p>Differential switch Recommended</p>	<p>300mA</p>

- The electric connection must be carried out by qualified personnel :

Connection Details	Furnace cables colour	Supply cables	
		Phase-Neutral 200-230V	Live-Live 240V
	Red or Brown	P	L1
	Blue	N	L2
	Green/ Yellow	E (ground)	

### Gas supply (for steel filaments only)



Working at a positive relative pressure is not recommended for this product. Gas supply relative pressure must not exceed 0.2 bar and the flanges must be well fitted.



Inert gas such as Argon are dangerous due to the asphyxiation hazard. The working area must be ventilated with an adequate venting system. Using of an oxygen gaz monitor is



Note :  
This product does **not** comply with the ATEX Directive and may **not** be used with flammable gases.

- Sintering parts are sintered under reducing atmosphere using a mix Argon-Hydrogen gas with 3.0% maximum of hydrogen gaz.
- A minimum gas capacity of minimum 2,5 m<sup>3</sup>(stp) is necessary to perform a sintering cycle.

Gas specification	Ar + H2 2,9 %max <i>(Linde ADDvance® sinter 250, Airliquide Arcal™ R1-2 or equivalent)</i>
Cylinder requirement	200 bar /50L/10.5 m3
Pressure reducer for connection to a 200 bar cylinder	 <p>Double stage Inlet max pressure : 200 bar (3000 psig) Outlet pressure : 0.05-1.00 bar (0-25 psig) Inlet fitting : Contact local gas cylinder supplier. Outlet fitting : OD 6 mm</p>

Supply gaz relative pressure must be set at 0.2 bar.

Please note that the pressure reducer 1 (cf p.7), the gas cylinder and the flexible air hose between the gas cylinder and the flowmeter are **not provided**.

### Set-up with gas equipment

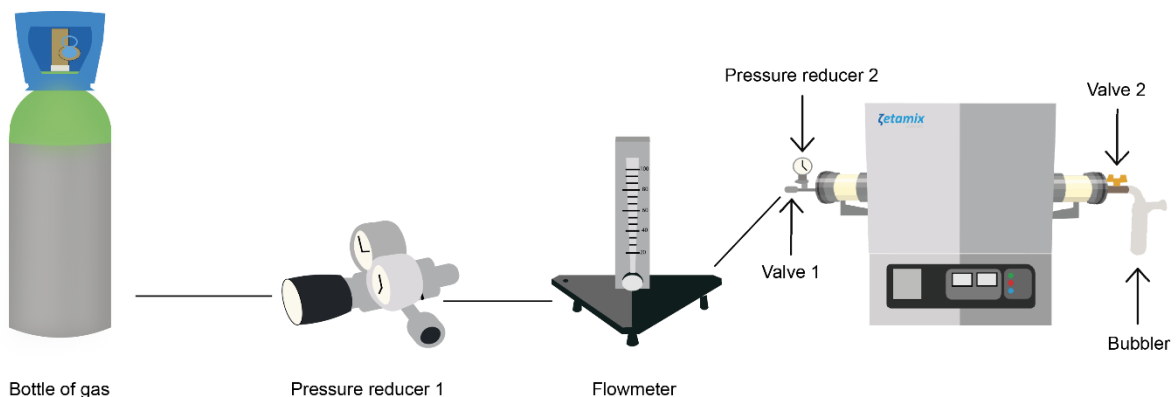

**Consumables list**

The Zetasinter Tubular 2947 is guaranteed for one year, except for parts considered as consumables, listed below:

- Refractory blocks
- Heating elements
- Alumina tube
- Alumina plate (crucible)
- Thermocouple
- Fusible
- Bubbler
- Flowmeter
- Inlet and outlet flange O-rings
- Inlet flange pressure gauge
- Vacuum pump

## 14. EU DECLARATION OF CONFORMITY (No 2018-11-a)

1. Product model: **Zetasinter Tubular Furnace**
2. Name and address of the manufacturer:

Nanoe SAS, 6 rue des frenes, 91160 Ballainvilliers

+339 81 98 33 64

3. This declaration of conformity is issued under the sole responsibility of the manufacturer. It is based on evaluation on a sampling of the aboved mentioned model.

4. Object of the declaration : Tube furnace model **Zetasinter Tubular Furnace**

5. The object of the declaration described above is in conformity with the relevant Union harmonisation legislation:

EU directive on low voltage electrical equipments 2014/35/UE

6. Applicable standards for this declaration are :

EN 60519-1/2015 : Safety in installations for electroheating and electromagnetic processing - Part 1: General requirements

EN 60519-2/2015 : Safety in electroheat installations - Part 2: Particular requirements for resistance heating equipment.

EN 50156-1/2015 : Electrical equipment for furnaces and ancillary equipment - Part 1: Requirements for application design and installation.

Signed for and on behalf of: Nanoe SAS

Ballainvilliers, on the 23/11/2018:

Guillaume de Calan, CEO

